Door Collection

Made to order cabinet doors and accessories

PRODUCT INFORMATION & PRICE GUIDE SUMMER 2014

Made to order cabinet doors and accessories

Any Size, Any Design, Any Colour

 infinity

deNOVO

CONTENTS

INFINITY PRICING

INFINITY COLLECTION PRICING

Group 1 Classic Designs Price Matrix	4
Group 1 Shaker Designs Price Matrix.....	5
Group 2 Classic Designs Price Matrix	6
Group 2 Shaker Designs Price Matrix.....	7
Group 3 Classic Designs Price Matrix	8
Group 3 Shaker Designs Price Matrix.....	9

INFINITY SPECIFICATION

INFINITY COLLECTION SPECIFICATIONS

Group 1 Colour Swatch.....	10
Group 2 Colour Swatch.....	13
Group 3 Colour Swatch.....	14
Door Finder Classic Designs.....	15
Door Finder Shaker Designs.....	17
Frames.....	18
Angled Doors.....	20

INFINITY ACCESSORIES

INFINITY COLLECTION ACCESSORIES

Accessories Price List.....	21
Cornice & Light Pelmet Options.....	22
Curved Door Specification.....	23
Accessories	24
Hinge Hole Drilling Guidelines.....	27
Order form	34

DENOVO

DENOVO COLLECTION PRICING & SPECIFICATIONS

Solid Colours Price Matrix	28
Metallic Colours Price Matrix	28
Colour Swatch	29
Edging Options & Accessories	30
Order form	35

HANDLE COLLECTION

HANDLE COLLECTION

Handles	32
Handles Price Matrix.....	33

B & R

Carpentry & Joinery

...for our wide range of made to order kitchen, bedroom and bathroom doors and accessories.

The products listed in this guide are subject to our terms and conditions of sale. All prices quoted are in pounds sterling and are subject to VAT.



Ney Limited (Head office)

T: +44 (0)24 76 308100 | F: +44 (0)24 76 308102 | E: doors@ney.co.uk

Ney Ireland

T: +44 (0)28 9267 3000 | F: +44 (0)28 9267 2999 | E: ireland@ney.co.uk

Ney Scotland

T: +44 (0)1786 814 814 | F: +44 (0)1786 814 812 | E: doors@ney.co.uk

RANGE INTRODUCTION



The Infinity collection of vinyl wrapped doors and accessories can be manufactured to meet your exact requirements. All designs are available in non-standard sizes, ensuring complete continuity throughout your kitchen, bedroom or bathroom. A superb selection of high quality accessories complete the range. All of the products in the Infinity collection are manufactured to the highest industry standards, using the finest raw materials which are then rigorously inspected prior to delivery. The result is that you get the design that you want, configured to fit your home and your lifestyle. The possibilities are endless.



DeNovo by Ney Ltd is a range of acrylic edged doors and accessories. The range consists of fourteen stunning high gloss acrylic finishes and two edging options. As with all the Ney Door Collection ranges, the DeNovo range is made-to-measure to suit your requirements, all doors are available in any colour and any size. An essential selection of matching accessories including 19mm thick end panels or 38mm thick block gables are also available to complete a sleek, ultra modern appearance.



ORDERING INFORMATION

Terms and Conditions of Sale

To enable us to process your orders efficiently all orders must be placed in writing by fax or e-mail. We cannot accept verbal orders. Copies of our order forms can be found on pages 34 and 35 within this guide which can be photocopied for use or if you would like us to send you some please contact us.

On receipt of an order, we will send an order acknowledgement detailing the complete order together with a despatch date. Despatch dates are dependant on proforma orders being paid with order and credit accounts being in order.

Please be aware that any order needing to be amended or cancelled after the 24 hour period will be liable for payment in full.

Please check this acknowledgement carefully and contact us within 24 hours if there are any corrections required, otherwise the order will be processed and put into production.

We endeavour to produce and despatch orders to a 10 day lead time.

We cannot be held responsible for incorrect ordering. Goods supplied correctly to order cannot be returned for credit.

Deliveries

Most deliveries are made by carrier. We know packages delivered by carrier can be subject to mis-handling, so in order to protect our customers and ourselves, on receipt of goods please check immediately. If there is any damage sign the docket accordingly and notify us immediately.

Claims for shortages or goods damaged in transit must be notified in writing within 3 working days of receipt of goods.

Claims for non-delivery must be notified in writing within 7 days of receipt of invoice.

Delivery Charges

England/Wales

Small orders up to the value of £100 will incur a carriage charge of £13.50

Orders of the value between £101 and £200 (within 50miles of Ney Ltd) will incur a charge of £25

Orders of the value between £101 and £250 (over 50 miles of Ney Ltd) will incur a charge of £25

Deliveries within 50 miles of Ney Ltd and with an order value over £200 - free of charge

Deliveries over 50 miles from Ney Ltd and with an order value over £250 - free of charge

Scotland

Small orders will be charged as per standard carrier charges

Orders below £450.00 in value will incur a charge of £45.00

Orders over £450.00 in value - free of charge

Scotland Highlands

Small orders will be charged as per standard carrier charges

Orders below £650.00 in value will incur a charge of £45.00

Orders over £650 in value - free of charge

Payments

All prices quoted are subject to VAT.

All goods remain the property of Ney Limited until they have been paid in full.

		Width up to (mm)									
		Grain	146	296	396	446	496	596	796	996	
Drawer Fronts	115	↔						7.62			
	140	↔		6.91	7.54	7.84	8.14	10.40	11.50	12.86	
	175	↔		7.59	8.13	8.54	8.89	11.28	12.83	14.35	
	215	↔		8.33	8.85	9.30	9.78	12.29	14.26	16.10	
Pan drawers	283	↕						16.31	17.54	18.90	20.04
	355	↕						17.86	19.43	22.08	24.97
Doors	Height up to (mm)	415	↕			17.44	18.33	19.24	21.06		
		450	↕						22.07		
		500	↕						23.18		
		535	↕			19.06		21.32	23.75		
		570	↕		17.12	19.52	20.78	21.99	24.31		
		650	↕		18.05	20.48	21.42	22.33	25.05		
		715	↕	12.71	18.99	21.43	22.06	22.69	25.79		
		895	↕		25.59	27.93		31.84	35.74		
		1100	↕			34.14		37.98	42.57		
		1245	↕		35.21	39.06		42.79	48.05		
Tall Doors <small>With centre rail where applicable</small>	1735	↕		47.57	49.62	53.41	57.16	59.79			
	2150	↕		53.04	55.87	60.22	64.59	68.57			
	2250	↕		56.82	59.97	63.66	68.27	74.69			
	2440	↕		58.43	64.77	70.05	75.27	85.80			

To calculate the price for any size simply use the grid to find the next size up for both height and width. E.g. to find the price for a 280x650 go to 283 on the left then across to 796 which gives a price of £18.90.

CURVED DOORS

Curved Classic Design doors are available in Modern Slab design only. Curved doors are supplied with Ivory or Steel backing only.

Type	Grain	Size (mm)	Price
External	↕	715 x 300 x 300	168.96
External	↕	895 x 300 x 300	181.10
External	↕	1245 x 300 x 300	193.27
External	↕	1595 x 300 x 300	217.58
External	↕	2150 x 300 x 300	267.41
External	↕	2250 x 300 x 300	278.10
Internal	↕	715 x 300 x 300	168.96

SUPPLEMENTS

- Drawer fronts are supplied with horizontal grain as standard. Drawer front designs incorporating vertical grain are supplied to a maximum width of 1245mm +10%.
- Doors are supplied with vertical grain as standard. Door designs can be supplied with horizontal grain to a maximum height of 1245mm +10%.
- Solid Mirror backs +75%
- Plain frames and full frames +25%.
- Georgian frames +50%.
- Feature frames +50%.
- Angled doors +50%.
- Doors can be supplied with square edges +10%. Specify left hand (LH) or right hand (RH) when ordering.
- Raw MDF doors -20%

CLASSIC DESIGNS

Amalfi, Ashford, Baltimore, Bilbao, Eclipse, Euroline, Florida, H Groove, Harrow, Linear, Lisbon, Markenfield, Miami, Modern Slab, Regent, Rushmere, Saponeta, Tudor, Vermont.
See door finder pages 15-16

		Width up to (mm)									
		Grain	146	296	396	446	496	596	796	996	
Drawer Fronts	115	↔						7.62			
	140	↔		6.91	7.54	7.84	8.14	10.40	11.50	12.86	
	175	↔		7.59	8.13	8.54	8.89	11.28	12.83	14.35	
	215	↔		8.33	8.85	9.30	9.78	12.29	14.26	16.10	
Pan drawers	283	↕					17.93	19.28	20.79	22.05	
	355	↕					19.65	21.37	24.29	27.47	
Doors	Height up to (mm)	415	↕			19.18	20.17	21.16	23.16		
		450	↕						24.28		
		500	↕						25.50		
		535	↕			20.97		23.45	26.12		
		570	↕		18.83	21.46	22.86	24.18	26.74		
		650	↕		19.86	22.52	23.56	24.57	27.55		
		715	↕	13.98	20.90	23.57	24.27	24.96	28.37		
		895	↕		28.15	30.72		35.03	39.32		
		1100	↕			37.55		41.78	46.82		
		1245	↕		38.72	42.97		47.07	52.85		
Tall Doors <small>With centre rail where applicable</small>	1735	↕		52.32	54.59	58.76	62.88	65.77			
	2150	↕		58.34	61.47	66.24	71.04	75.42			
	2250	↕		62.50	65.96	70.02	75.10	82.15			
	2440	↕		64.28	71.25	77.05	82.80	94.37			

To calculate the price for any size simply use the grid to find the next size up for both height and width. E.g. to find the price for a 280x650 go to 283 on the left then across to 796 which gives a price of £20.79.

CURVED DOORS

Curved Shaker design doors are available in Siskin Shaker design only. Curved doors are supplied with Ivory or Steel backing only.

Type	Grain	Size (mm)	Price
External	↕	715 x 300 x 300	185.85
External	↕	895 x 300 x 300	199.22
External	↕	1245 x 300 x 300	212.60
External	↕	1595 x 300 x 300	239.34
External	↕	2150 x 300 x 300	294.16
External	↕	2250 x 300 x 300	305.92

SUPPLEMENTS

- Drawer fronts are supplied with horizontal grain as standard. Drawer front designs incorporating vertical grain are supplied to a maximum width of 1245mm +10%.
- Doors are supplied with vertical grain as standard. Door designs can be supplied with horizontal grain to a maximum height of 1245mm +10%.
- Solid Mirror backs +75%
- Plain frames and full frames +25%.
- Georgian frames +50%.
- Feature frames are not available in Shaker designs.
- Angled doors +50%.
- Doors can be supplied with square edges +10%. Specify left hand (LH) or right hand (RH) when ordering.
- Raw MDF doors -20%

SHAKER DESIGNS

Ashbury Shaker, Beaded Shaker, Bevelled Shaker, Harvard Shaker, Paris Shaker, Portland Shaker, Siskin Shaker, Westbury Shaker. See door finder page 17

		Width up to (mm)									
		Grain	146	296	396	446	496	596	796	996	
Drawer Fronts	115	↔						9.90			
	140	↔		8.99	9.81	10.20	10.57	13.51	14.95	16.73	
	175	↔		9.87	10.56	11.10	11.57	14.66	16.68	18.66	
	215	↔		10.83	11.51	12.10	12.72	15.97	18.53	20.93	
Pan drawers	283	↕						21.20	22.79	24.57	26.06
	355	↕						23.22	25.25	28.71	32.47
Doors	Height up to (mm)	415	↕			22.67	23.84	25.01	27.37		
		450	↕						28.70		
		500	↕						30.15		
		535	↕			24.78		27.71	30.87		
		570	↕		22.24	25.37	27.02	28.58	31.61		
		650	↕		23.47	26.62	27.85	29.03	32.56		
		715	↕	16.51	24.70	27.87	28.68	29.49	33.53		
		895	↕		33.26	36.31		41.39	46.46		
		1100	↕			44.37		49.37	55.34		
		1245	↕		45.76	50.78		55.63	62.46		
Tall Doors <small>With centre rail where applicable</small>	1735	↕		61.83	64.51	69.44	74.32	77.72			
	2150	↕		68.94	72.64	78.29	83.96	89.13			
	2250	↕		73.86	77.95	82.76	88.75	97.09			
	2440	↕		75.97	84.20	91.06	97.86	111.53			

To calculate the price for any size simply use the grid to find the next size up for both height and width. E.g. to find the price for a 280x650 go to 283 on the left then across to 796 which gives a price of £24.57.

CURVED DOORS

Curved Classic design gloss doors are available in Modern Slab design only. Curved doors are supplied with Ivory or Steel backing only.

Type	Grain	Size (mm)	Price
External	↕	715 x 300 x 300	196.67
External	↕	895 x 300 x 300	210.81
External	↕	1245 x 300 x 300	224.95
External	↕	1595 x 300 x 300	253.25
External	↕	2150 x 300 x 300	311.26
External	↕	2250 x 300 x 300	323.72
Internal	↕	715 x 300 x 300	196.67

SUPPLEMENTS

- Solid Mirror backs +75%
- Plain Frames and full frames +25%.
- Feature Frames +50%
- Georgian frames are not available in gloss colours.
- Angled doors +50%.
- Doors can be supplied with square edges +10%. Specify left hand (LH) or right hand (RH) when ordering.

CLASSIC DESIGNS

Amalfi, Ashford, Baltimore, Bilbao, Eclipse, Euroline, Florida, H Groove, Harrow, Linear, Lisbon, Markenfield, Miami, Modern Slab, Regent, Rushmere, Saponeta, Tudor, Vermont.
See door finder pages 15-16

		Width up to (mm)									
		Grain	146	296	396	446	496	596	796	996	
Drawer Fronts	115	↔						9.90			
	140	↔		8.99	9.81	10.20	10.57	13.51	14.95		
	175	↔		9.87	10.56	11.10	11.57	14.66	16.68	18.66	
	215	↔		10.83	11.51	12.10	12.72	15.97	18.53	20.93	
Pan drawers	283	↕					23.32	25.06	27.03	28.67	
	355	↕					25.54	27.78	31.58	35.71	
Doors	Height up to (mm)	415	↕			24.94	26.22	27.51	30.11		
		450	↕						31.56		
		500	↕						33.16		
		535	↕			27.26		30.47	33.96		
		570	↕		24.47	27.91	29.72	31.44	34.77		
		650	↕		25.82	29.27	30.63	31.94	35.82		
		715	↕	18.17	27.16	30.65	31.55	32.45	36.88		
		895	↕		36.59	39.93		45.53	51.11		
		1100	↕			48.81		54.32	60.87		
		1245	↕		50.34	55.86		61.18	68.71		
Tall Doors <small>With centre rail where applicable</small>	1735	↕		68.01	70.96	76.39	81.74	85.50			
	2150	↕		75.83	79.91	86.11	92.36	98.05			
	2250	↕		81.24	85.75	91.04	97.62	106.80			
	2440	↕		83.56	92.62	100.16	107.65	122.69			

To calculate the price for any size simply use the grid to find the next size up for both height and width. E.g. to find the price for a 280x650 go to 283 on the left then across to 795 which gives a price of £ 27.03.

CURVED DOORS

Curved Shaker design gloss doors are available in Siskin Shaker design only. Curved doors are supplied with Ivory or Steel backing only.

Type	Grain	Size (mm)	Price
External	↕	715 x 300 x 300	216.33
External	↕	895 x 300 x 300	231.89
External	↕	1245 x 300 x 300	247.44
External	↕	1595 x 300 x 300	278.58
External	↕	2150 x 300 x 300	342.38
External	↕	2250 x 300 x 300	356.09

SUPPLEMENTS

- Solid Mirror backs +75%
- Plain Frames and full frames +25%.
- Feature Frames are not available in Shaker designs.
- Georgian frames are not available in gloss colours.
- Angled doors +50%.
- Doors can be supplied with square edges +10%. Specify left hand (LH) or right hand (RH) when ordering.

SHAKER DESIGNS

Ashbury Shaker, Beaded Shaker, Bevelled Shaker, Harvard Shaker, Paris Shaker, Portland Shaker, Siskin Shaker, Westbury Shaker. See door finder page 17

		Width up to (mm)									
		Grain	146	296	396	446	496	596	796	996	
Drawer Fronts	115	↔						11.42			
	140	↔		10.37	11.31	11.76	12.20	15.59	17.25	19.30	
	175	↔		11.39	12.19	12.80	13.35	16.92	19.25	21.54	
	215	↔		12.48	13.28	13.95	14.67	18.43	21.38	24.15	
Pan drawers	283	↕					24.45	26.29	28.35	30.06	
	355	↕					26.80	29.14	33.13	37.45	
Doors	Height up to (mm)	415	↕			26.17	27.50	28.85	31.58		
		450	↕						33.11		
		500	↕						34.78		
		535	↕			28.59		31.96	35.63		
		570	↕		25.66	29.27	31.17	32.98	36.47		
		650	↕		27.08	30.71	32.13	33.51	37.57		
		715	↕	19.05	28.50	32.15	33.10	34.03	38.68		
		895	↕		38.39	41.88		47.76	53.61		
		1100	↕			51.20		56.97	63.85		
		1245	↕		52.80	58.59		64.19	72.07		
Tall Doors <small>With centre rail where applicable</small>	1735	↕		71.35	74.43	80.13	85.74	89.68			
	2150	↕		79.55	83.81	90.33	96.87	102.85			
	2250	↕		85.22	89.94	96.54	102.40	112.02			
	2440	↕		87.65	97.16	105.06	112.92	128.70			

To calculate the price for any size simply use the grid to find the next size up for both height and width. E.g. to find the price for a 280x650 go to 283 on the left then across to 795 which gives a price of £28.35.

CURVED DOORS

Curved Classic design gloss doors are available in Modern Slab design only. Curved doors are supplied with Ivory or Steel backing only.

Type	Grain	Size (mm)	Price
External	↕	715 x 300 x 300	226.17
External	↕	895 x 300 x 300	242.43
External	↕	1245 x 300 x 300	258.70
External	↕	1595 x 300 x 300	291.24
External	↕	2150 x 300 x 300	357.96
External	↕	2250 x 300 x 300	372.28
Internal	↕	715 x 300 x 300	226.17

SUPPLEMENTS

- Drawer fronts are supplied with horizontal grain as standard. Drawer front designs incorporating vertical grain are supplied to a maximum width of 1245mm +10%.
- Doors are supplied with vertical grain as standard. Door designs can be supplied with horizontal grain to a maximum height of 1245mm +10%.
- Solid Mirror backs +75%
- Plain frames and full frame +25%.
- Feature Frames +50%.
- Georgian frames are not available in gloss colours.
- Angled doors +50%.
- Doors can be supplied with square edges +10%. Specify left hand (LH) or right hand (RH) when ordering.

CLASSIC DESIGNS

Amalfi, Ashford, Baltimore, Bilbao, Eclipse, Euroline, Florida, H Groove, Harrow, Linear, Lisbon, Markenfield, Miami, Modern Slab, Regent, Rushmere, Saponeta, Tudor, Vermont.
See door finder pages 15-16

		Width up to (mm)									
		Grain	146	296	396	446	496	596	796	996	
Drawer Fronts	115	↔						11.42			
	140	↔		10.37	11.31	11.76	12.20	15.59	17.25	19.30	
	175	↔		11.39	12.19	12.80	13.35	16.92	19.25	21.54	
	215	↔		12.48	13.28	13.95	14.67	18.43	21.38	24.15	
Pan drawers	283	↕					26.90	28.93	31.19	33.08	
	355	↕					29.47	32.06	36.44	41.20	
Doors	Height up to (mm)	415	↕			28.78	30.25	31.74	34.74		
		450	↕						36.41		
		500	↕						38.25		
		535	↕			31.45		35.16	39.19		
		570	↕		28.23	32.20	34.29	36.28	40.11		
		650	↕		29.79	33.78	35.34	36.86	41.33		
		715	↕	20.96	31.34	35.36	36.40	37.43	42.55		
		895	↕		42.22	46.07		52.53	58.98		
		1100	↕			56.32		62.66	70.23		
		1245	↕		58.09	64.45		70.60	79.28		
Tall Doors <small>With centre rail where applicable</small>	1735	↕		78.48	81.88	88.14	94.32	98.65			
	2150	↕		87.50	92.19	99.36	106.56	113.13			
	2250	↕		93.74	98.94	105.03	112.64	123.23			
	2440	↕		96.41	106.87	115.57	124.22	141.56			

To calculate the price for any size simply use the grid to find the next size up for both height and width. E.g. to find the price for a 280x650 go to 283 on the left then across to 795 which gives a price of £ 31.19.

CURVED DOORS

Curved Shaker design gloss doors are available in Siskin Shaker designs only. Curved doors are supplied with Ivory or Steel backing only.

Type	Grain	Size (mm)	Price
External	↕	715 x 300 x 300	248.78
External	↕	895 x 300 x 300	266.67
External	↕	1245 x 300 x 300	284.56
External	↕	1595 x 300 x 300	320.37
External	↕	2150 x 300 x 300	393.75
External	↕	2250 x 300 x 300	409.50

SHAKER DESIGNS

Ashbury Shaker, Beaded Shaker, Bevelled Shaker, Harvard Shaker, Paris Shaker, Portland Shaker, Siskin Shaker, Westbury Shaker. See door finder page 17

SUPPLEMENTS

- Drawer fronts are supplied with horizontal grain as standard. Drawer front designs incorporating vertical grain are supplied to a maximum width of 1245mm +10%.
- Doors are supplied with vertical grain as standard. Door designs can be supplied with horizontal grain to a maximum height of 1245mm +10%.
- Solid Mirror backs +75%
- Plain frames and full frame +25%.
- Feature Frames are not available in shaker designs.
- Georgian frames are not available in gloss colours.
- Angled doors +50%.
- Doors can be supplied with square edges +10%. Specify left hand (LH) or right hand (RH) when ordering.

GROUP 1 COLOUR SWATCH

AFRICAN WALNUT Production Backing: Matching 	ARONA NATURAL ELM Production Backing: Sonoma Natural Oak 	ARONA TRUFFLE ELM Production Backing: Swiss Elm 	CANADIAN MAPLE Production Backing: Matching 
CLASSIC WALNUT Production Backing: Matching 	MONTANA OAK Production Backing: Matching 	NATURAL WALNUT Production Backing: Matching 	ODESSA GOLDEN OAK SAW CUT Production Backing: Odessa Oak 
ODESSA GREY OAK SAW CUT Production Backing: Matching 	ODESSA OAK Production Backing: Matching 	PIPPY OAK Production Backing: Matching 	SONOMA NATURAL OAK Production Backing: Matching 
SONOMA TRUFFLE OAK Production Backing: Matching 	STEINBERG BEECH Production Backing: Matching 	SWISS ELM Production Backing: Matching 	TRADITIONAL OAK Production Backing: Matching 

GROUP 1 COLOUR SWATCH

<p>SMOOTH BASALT Production Backing: Ivory</p> 	<p>SMOOTH DAKAR Production Backing: Matching</p> 	<p>SMOOTH IVORY Production Backing: Matching</p> 	<p>SMOOTH KASHMIR Production Backing: Matching</p> 
<p>SMOOTH MUSSEL Production Backing: Matching</p> 	<p>SMOOTH OLIVE Production Backing: Dakar</p> 	<p>SMOOTH PORCELAIN Production Backing: White</p> 	<p>SMOOTH STONE Production Backing: Mussel</p> 
<p>SMOOTH VANILLA Production Backing: Matching</p> 	<p>SMOOTH WHITE Production Backing: Matching</p> 		

GROUP 1 COLOUR SWATCH



Supplied horizontal grain only

Supplied horizontal grain only

GROUP 2 COLOUR SWATCH

<p>GLOSS ALABASTER Production Backing: Ivory</p> 	<p>GLOSS AUBERGINE Production Backing: Steel</p> 	<p>GLOSS BEIGE Production Backing: Ivory</p> 	<p>GLOSS BLACK Production Backing: Black</p> 
<p>GLOSS JASMINE Production Backing: Ivory</p> 	<p>GLOSS LATTE Production Backing: Ivory</p> 	<p>GLOSS RED Production Backing: Steel</p> 	<p>GLOSS WHITE Production Backing: White</p> 
<p>MAGIC BLUE Production Backing: Steel</p> 	<p>MAGIC BRONZE Production Backing: Steel</p> 	<p>MAGIC GOLD Production Backing: Steel</p> 	<p>MAGIC GREEN Production Backing: Steel</p> 
<p>MAGIC GREY Production Backing: Steel</p> 			

GROUP 3 COLOUR SWATCH

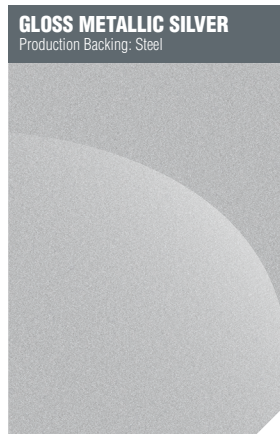
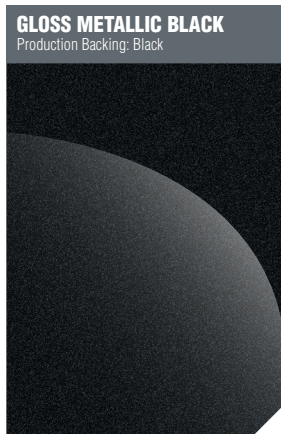

PRODUCTION BACKING & MATCHING MFC

Vinyl Colour	Production Backing	Matching MFC		
		Pfleiderer	Kronospan	Egger
African Walnut	Matching		D8311	
Arona Natural Elm	Sonoma Nat Oak			
Arona Truffle Elm	Swiss Elm	R5643		
Canadian Maple	Matching	R5479	D0364	H1869
Carbon Cedar	Matching			H3081
Classic Walnut	Matching	R4889	D0481	H3704
Concrete	White			F274
Gloss Alabaster	Ivory	U1306 HG		U222 ST30
Gloss Aubergine	Steel	U141 HG		
Gloss Beige	Ivory	U1343 HG		U156 ST30
Gloss Black	Black	U007 HG		U999 ST30
Gloss Jasmine	Ivory			U104 ST30
Gloss Latte	Ivory	U197 HG		
Gloss Metallic Black	Black			
Gloss Metallic Silver	Steel			
Gloss Red	Steel	U1691 HG		
Gloss Walnut	Natural Walnut	R4811 HG		
Gloss White	White	SR209 HG		W1000 ST30
Gloss Zebbrano	Steel			
Magic Blue	Steel			
Magic Bronze	Steel			
Magic Gold	Steel			
Magic Green	Steel			
Magic Grey	Steel			
Modern Graphite	Black			
Modern White	White			
Montana Oak	Matching		D1929	H1342
Natural Walnut	Matching	R4899	D0726	H3703

Vinyl Colour	Production Backing	Matching MFC		
		Pfleiderer	Kronospan	Egger
Odessa Golden Oak Saw Cut	Odessa Oak	R4214	D6540	
Odessa Grey Oak Saw Cut	Matching		D6539	
Odessa Oak	Matching	R4214	D6540	
Pippy Oak	Matching	R4241	D9277	H1381
Smooth Basalt	Ivory			
Smooth Dakar	Matching			U717
Smooth Ivory	Matching	U1303	U0514	U104
Smooth Kashmir	Matching			U702
Smooth Mussel	Matching	U1331		U100
Smooth Olive	Dakar	U1193		U631
Smooth Porcelain	White			W1200
Smooth Stone	Mussel	U1191		U727
Smooth Vanilla	Matching	U116	U0519	U108
Smooth White	Matching	W300	K0101	W980
Sonoma Natural Oak	Matching	R4110	D8197	H1145
Sonoma Truffle Oak	Matching	R4285		H1158
Steinberg Beech	Matching		D6675	
Swiss Elm	Matching		D6597	
Traditional Oak	Matching	R4276	D8925	
Woodgrain Basalt	Ivory			
Woodgrain Dakar	Dakar			U717
Woodgrain Ivory	Ivory	U1303 MO	U0514	U104
Woodgrain Kashmir	Kashmir			U702
Woodgrain Mussel	Mussel	U1331 MO		U100
Woodgrain Porcelain	White			W1200
Woodgrain Stone	Mussel	U1191 MO		U727
Woodgrain White	White	W300 MO	K0101	W980

25mm board is supplied with Kronospan K101 white backing only. Steel backing is Pfleiderer F8110. Please also note that although our steel MDF has a textured appearance this is not considered as grain and therefore will not be treated as directional throughout an order. The MFC decors listed are the "best match" as per information from our suppliers.

Note that these are recommendations only and you are advised to check and compare our swatches with colour samples from your supplier before ordering cabinet material. We will accept no liability for claims arising from apparent variations in colour or effect between cabinets and doors.

DOOR FINDER CLASSIC DESIGNS

Prices can be found on pages 4, 6 & 8



AMALFI

Min Drawer Height: 100mm
 Min Drawer Width: 100mm
 Min Door Width: 185mm
 Min Door Height: 185mm
 Stile Width: 75mm



F ✓



ASHFORD

Min Drawer Height: 110mm
 Min Drawer Width: 195mm
 Min Door Width: 225mm
 Min Door Height: 225mm
 Stile Width: 69mm

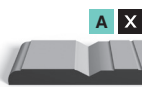

A X



BALTIMORE

Min Drawer Height: 110mm
 Min Drawer Width: 215mm
 Min Door Width: 215mm
 Min Door Height: 215mm
 Stile Width: 57mm



E X



BILBAO/MIAMI*

Min Drawer Height: 100mm
 Min Drawer Width: 210mm
 Min Door Width: 210mm
 Min Door Height: 100mm
 Stile Width: N/A
 Bilbao - Horizontal Grain
 Miami - Vertical Grain
 Bilbao not available over 1245mm in height.
 Handle - 200mm overall width, available in Satin Chrome

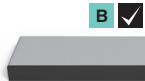

B ✓

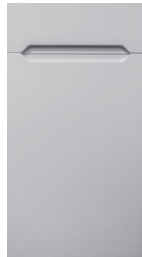

ECLIPSE*

Min Drawer Height: 100mm
 Min Drawer Width: 160mm
 Min Door Width: 160mm
 Min Door Height: 100mm
 Stile Width: N/A
 Handle: Doors/Drawers under 1700mm handle will start 75mm from each side on horizontal side. Doors over 1700mm handles will start 400mm from each side on vertical side.

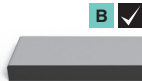

B ✓



EUROLINE

Min Drawer Height: 115mm
 Min Drawer Width: 115mm
 Min Door Width: 115mm
 Min Door Height: 115mm
 Stile Width: 50mm



D ✓



FLORIDA/LISBON*

Min Drawer Height: 100mm
 Min Drawer Width: 140mm
 Min Door Width: 140mm
 Min Door Height: 100mm
 Stile Width: N/A
 Lisbon - Horizontal Grain
 Florida - Vertical Grain
 Lisbon Doors not available over 1245mm in height.
 Handle - 130mm overall width, available in Polished Chrome.

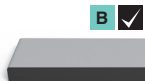

B ✓



H GROOVE

Min Drawer Height: 110mm
 Min Drawer Width: 205mm
 Min Door Width: 205mm
 Min Door Height: 205mm
 Stile Width: 70mm



B ✓



HARROW

Min Drawer Height: 110mm
 Min Drawer Width: 270mm
 Min Door Width: 270mm
 Min Door Height: 270mm
 Stile Width: 85mm



B X



* please refer to page 27 for drilling information

DOOR FINDER CLASSIC DESIGNS

Prices can be found on pages 4, 6 & 8



LINEAR

Min Drawer Height: 100mm
Min Drawer Width: 135mm
Min Door Width: 135mm
Min Door Height: 100mm
Stile Width: 65mm



MARKENFIELD

Min Drawer Height: 100mm
Min Drawer Width: 100mm
Min Door Width: 100mm
Min Door Height: 100mm
Stile Width: N/A



MODERN SLAB

Min Drawer Height: 100mm
Min Drawer Width: 100mm
Min Door Width: 100mm
Min Door Height: 100mm
Stile Width: N/A



REGENT

Min Drawer Height: 110mm
Min Drawer Width: 150mm
Min Door Width: 205mm
Min Door Height: 205mm
Stile Width: 64mm



RUSHMERE

Min Drawer Height: 100mm
Min Drawer Width: 100mm
Min Door Width: 225mm
Min Door Height: 240mm
Stile Width: 69mm

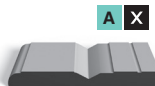

SAPONETA

Min Drawer Height: 100mm
Min Drawer Width: 100mm
Min Door Width: 100mm
Min Door Height: 100mm
Stile Width: N/A



TUDOR

Min Drawer Height: 100mm
Min Drawer Width: 160mm
Min Door Width: 205mm
Min Door Height: 205mm
Stile Width: 70mm



VERMONT

Min Drawer Height: 100mm
Min Drawer Width: 100mm
Min Door Width: 205mm
Min Door Height: 205mm
Stile Width: 64mm



KEY

- A** Profile (See below)
- Available in Gloss Finish
- Not available in Gloss Finish

PROFILES

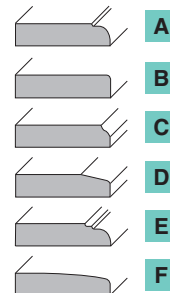

DOOR FINDER SHAKER DESIGNS

Prices can be found on page 5, 7 & 9



ASHBURY SHAKER

Min Drawer Height: 100mm
 Min Drawer Width: 185mm
 Min Door Width: 215mm
 Min Door Height: 215mm
 Stile Width: 90mm



BEADED SHAKER

Min Drawer Height: 100mm
 Min Drawer Width: 100mm
 Min Door Width: 235mm
 Min Door Height: 235mm
 Stile Width: 90mm



BEVELLED SHAKER

Min Drawer Height: 100mm
 Min Drawer Width: 205mm
 Min Door Width: 235mm
 Min Door Height: 235mm
 Stile Width: 100mm



HARVARD SHAKER

Min Drawer Height: 100mm
 Min Drawer Width: 100mm
 Min Door Width: 250mm
 Min Door Height: 250mm
 Stile Width: 80mm



PARIS SHAKER

Min Drawer Height: 100mm
 Min Drawer Width: 100mm
 Min Door Width: 265mm
 Min Door Height: 265mm
 Stile Width: 90mm



PORTLAND SHAKER

Min Drawer Height: 100mm
 Min Drawer Width: 190mm
 Min Door Width: 275mm
 Min Door Height: 275mm
 Stile Width: 90mm



SISKIN SHAKER

Min Drawer Height: 100mm
 Min Drawer Width: 100mm
 Min Door Width: 215mm
 Min Door Height: 215mm
 Stile Width: 90mm



WESTBURY SHAKER

Min Drawer Height: 100mm
 Min Drawer Width: 100mm
 Min Door Width: 215mm
 Min Door Height: 215mm
 Stile Width: 90mm



KEY

- A** Profile (See below)
- Available in Gloss Finish
- Not available in Gloss Finish
- 3mm Flat Groove
- 45° V-Groove

PROFILES

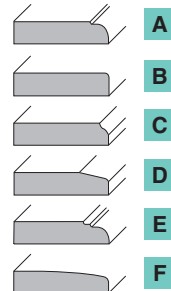

FRAME CLASSIC & SHAKER DESIGNS

BEDROOM SIZES - OVER 1700MM

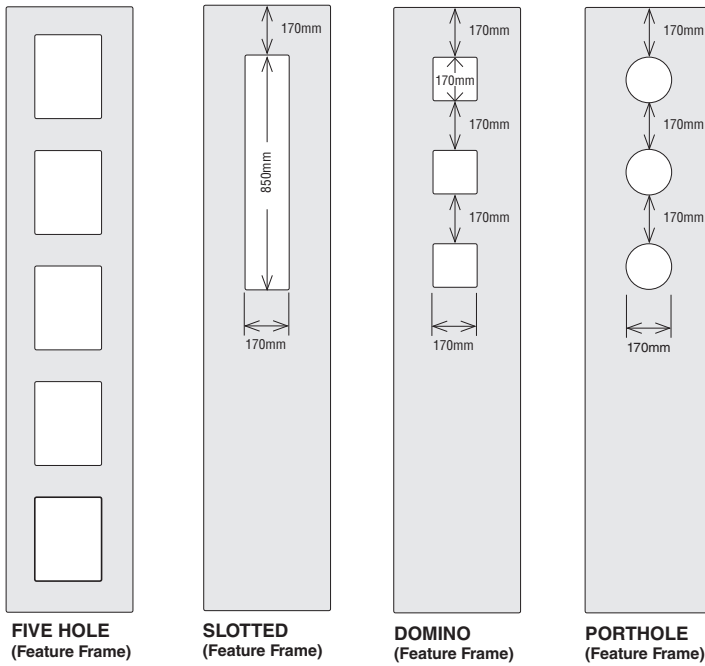
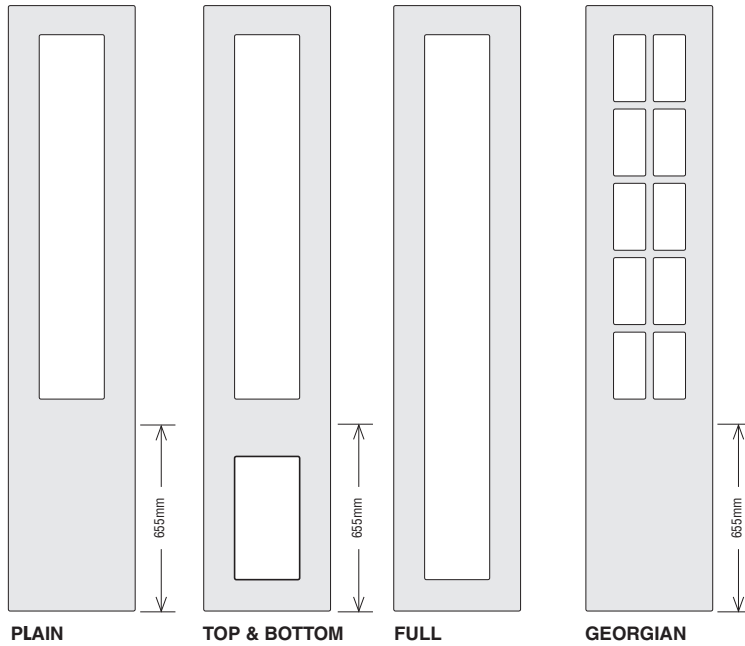

KITCHEN SIZES - UP TO 1700MM

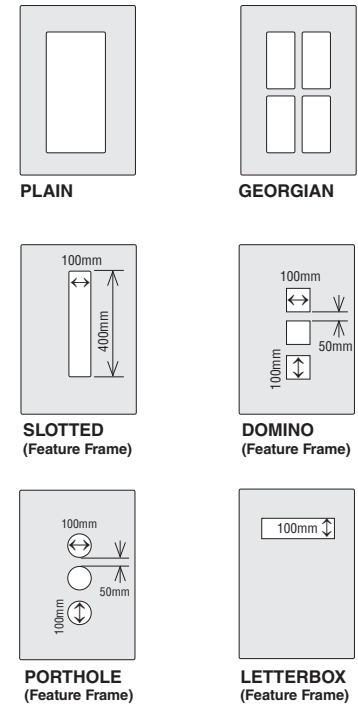

SOLID BACK FRAME REBATE

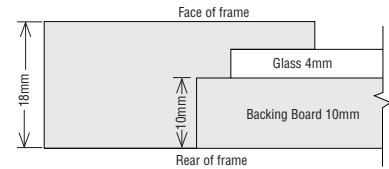

STANDARD FRAME REBATE

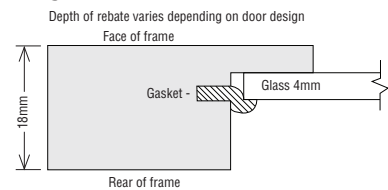

GUIDELINES FOR ORDERING FRAMES

All frames are supplied unglazed and are manufactured with a rebate and groove to accept 4mm or 5mm glass to be held in place with a rubber gasket which is included. Open top and bottom frames are limited to designs which would normally contain a centre rail. Georgian frames over 1700mm in height are supplied as open top only. Other feature frames are available as shown and should be ordered as per description given.

FRAME CLASSIC & SHAKER DESIGNS

DESIGN OPTIONS

Door Design	Door Range	Plain Frame	Full Frame	Feature Frame	Georgian Frame	Top & Bottom	Frame Stile (A)	Rebated Stile (B)	Example Rebate Size (715x495 mm Frame)	
									Height (mm)	Width (mm)
Amalfi	Classic	✓	✓	✓	x	x	100	88	539	319
Ashbury Shaker	Shaker	✓	✓	x	✓	✓	90	78	559	339
Ashford	Classic	✓	✓	x	✓	✓	76	64	587	367
Baltimore	Classic	✓	✓	x	✓	✓	68	56	603	383
Beaded Shaker	Shaker	✓	✓	x	✓	✓	95	83	549	329
Bevelled Shaker	Shaker	✓	✓	x	✓	✓	100	88	539	319
Bilbao	Classic	✓	x	✓	x	x	80	68	579	359
Eclipse	Classic	✓	✓	✓	x	x	80	68	579	359
Euroline	Classic	✓	✓	✓	x	x	80	68	579	359
Florida	Classic	✓	✓	✓	x	x	80	68	579	359
H Groove	Classic	✓	✓	x	✓	✓	70	58	599	379
Harrow	Classic	✓	✓	x	✓	✓	95	83	549	329
Harvard Shaker	Shaker	✓	✓	x	✓	✓	90	78	559	339
Linear	Classic	✓	✓	✓	x	x	60	48	619	399
Lisbon	Classic	✓	x	✓	x	x	80	68	579	359
Markenfield	Classic	✓	✓	✓	x	x	80	68	579	359
Miami	Classic	✓	✓	✓	x	x	80	68	579	359
Modern Slab	Classic	✓	✓	✓	x	x	80	68	579	359
Paris Shaker	Shaker	✓	✓	x	✓	✓	100	88	539	319
Portland Shaker	Shaker	✓	✓	x	✓	✓	90	78	559	339
Regent	Classic	✓	✓	x	✓	✓	76	64	587	367
Rushmere	Classic	✓	✓	x	✓	✓	76	64	587	367
Saponeta	Classic	✓	✓	✓	x	x	80	68	579	359
Siskin Shaker	Shaker	✓	✓	x	✓	✓	90	78	559	339
Tudor	Classic	✓	✓	x	✓	✓	70	58	599	379
Vermont	Classic	✓	✓	x	✓	✓	76	64	587	367
Westbury Shaker	Shaker	✓	✓	x	✓	✓	90	78	559	339

GUIDELINES FOR CALCULATING FRAME REBATE

The sketch shows a 715x495 Modern Slab Plain Frame rebate.

Frame Stile (A) = 80mm
Rebated Stile (B) = 68mm

To calculate the height of the rebate:

Height – (2x Rebated Stile) = Rebate Height
715 – (2x68) = 579

To calculate the width of the rebate:

Width – (2x Rebated Stile) = Rebate Width
495 – (2x68) = 359

Rebate size for a 715x495 Modern Slab Frame is 579x359.

It is recommended to order the glass a few millimetres smaller than the rebate size.

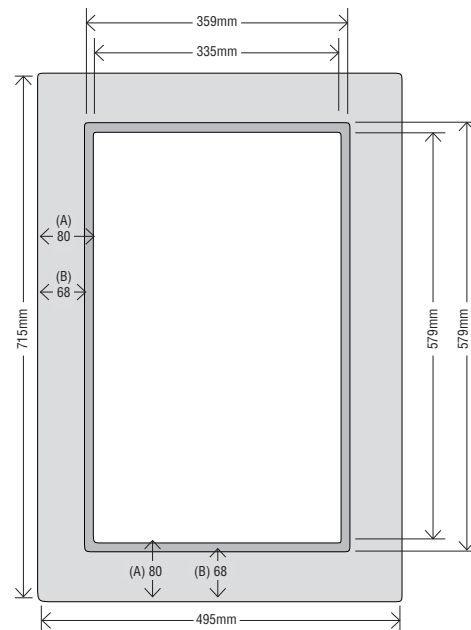

ANGLED DOORS GUIDELINES

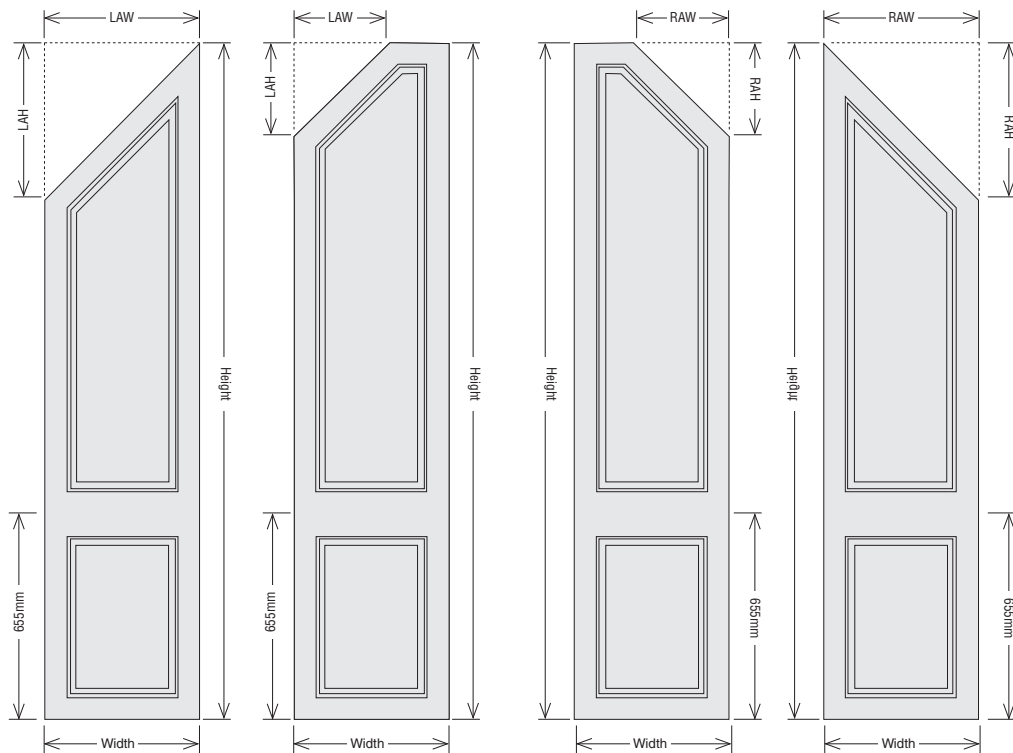

LAH Left Angle Height

LAW Left Angle Width

RAH Right Angle Height

RAW Right Angle Width

Design	Range	Angled
Amalfi	Classic	✓
Ashbury Shaker	Shaker	✓
Ashford	Classic	✓
Baltimore	Classic	✗
Beaded Shaker	Shaker	✓
Bevelled Shaker	Shaker	✓
Bilbao	Classic	✓
Eclipse	Classic	✓
Euroline	Classic	✓

Design	Range	Angled
Florida	Classic	✓
H Groove	Classic	✓
Harrow	Classic	✓
Harvard Shaker	Shaker	✓
Linear	Classic	✓
Lisbon	Classic	✓
Markenfield	Classic	✓
Miami	Classic	✓
Modern Slab	Classic	✓

Design	Range	Angled
Paris Shaker	Shaker	✓
Portland Shaker	Shaker	✓
Regent	Classic	✓
Rushmere	Classic	✗
Saponeta	Classic	✓
Siskin Shaker	Shaker	✓
Tudor	Classic	✓
Vermont	Classic	✗
Westbury Shaker	Shaker	✓

GUIDELINES FOR ORDERING ANGLED DOORS

Angled doors should be ordered by supplying the full height and width of the door along with the right or left angle heights and widths as shown. The mid rail position, where applicable, will be at 655mm from the bottom of the door to the centre of the rail unless otherwise requested. A separate drawing must be submitted. A line drawing giving an indication of the final door or doors will be sent to you for approval, this must be checked for accuracy then signed and returned prior to production.

ACCESSORIES PRICE LIST

No.	Accessories	Unit	Group 1	Group 2	Group 3	Raw MDF
1	Tangent Cornice 3m Length	Each	17.98			14.38
2	Tangent Light Pelmet 3m Length	Each	16.45			13.16
3	Universal Corpel 3m Length	Each	25.00	32.51	37.51	20.00
4	25mm Moulded Corpel 2.4m length	Each	22.15	28.79	33.23	17.72
5	Radius Profile 3000mm x 60mm x 60mm	Each	41.69	54.71	63.12	33.35
6	50mm Moulded Corpel 2.4m length	Each	39.94	51.92	59.91	31.95
7	Corner Post 750mm x 40mm x 40mm	Each	14.28	18.56	21.42	11.42
8	Tangent Curved Cornice (Internal or External) 300mm x 300mm	Each	39.94			31.95
9	Tangent Curved Pelmet (Internal or External) 300mm x 300mm	Each	39.94			31.95
10	Tangent Quadrant	Each	27.21			21.77
11	25mm Curved Moulded Corpel (Internal or External) 300mm x 300mm	Each	30.43	39.56	45.65	24.34
12	25mm Moulded Corpel Quadrant	Each	18.14	23.59	27.22	14.51
13	50mm Curved Moulded Corpel (Internal or External) 300mm x 300mm	Each	22.15	28.79	33.23	17.72
14	50mm Moulded Corpel Quadrant	Each	27.21	35.38	40.83	21.77
15	Plain Curved Plinth (Internal or External) 300mm x 300mm x 150mm	Each	49.20	63.96	73.80	39.36
16	Angled Plain or Angled Moulded Panel (18mm) Min price £12.50	per m ²	73.25	95.23	109.89	58.60
16	Angled Plain or Angled Moulded Panel (25mm) Min price £17.50	per m ²	102.69	133.50	154.50	82.15
17	T&G Panel Min price £12.50	per m ²	73.25			58.60
18	Plain or Moulded Panel (18mm) Min price £10.00	per m ²	58.66	76.26	87.99	46.93
18	Plain or Moulded Panel (25mm) Min price £14.00	per m ²	82.12	106.76	123.18	65.70
18	Plain or Moulded Plinth (18mm) 2440mm x 150mm	Each	18.93	24.61	28.39	15.14
19	Wall Shelf Unit 720mm x 300mm x 300mm	Each	42.11	54.74	63.16	33.69
19	Wall Shelf Unit 900mm x 300mm x 300mm	Each	48.14	62.59	72.22	38.51
20	Curved Corner Unit 720mm x 300mm x 300mm	Each	42.11	54.74	63.16	33.69
21	Base Shelf Unit 720mm x 300mm x 570mm RH/LH	Each	67.68	87.99	101.52	54.14
22	Plain Canopy 1035mm x 450mm C/W Base Can be Cut to 800mm	Each	172.92	224.81	259.39	
22	Plain Canopy 710mm x 450mm C/W Base Can be Cut to 600mm	Each	159.25	207.03	238.89	
23	T&G Canopy 1035mm x 450mm C/W Base Can be Cut to 800mm	Each	172.92			
23	T&G Canopy 710mm x 450mm C/W Base Can be Cut to 600mm	Each	159.25			
24	Overmantle A	Each	198.00	257.40	296.01	158.40
25	Overmantle B	Each	198.00	257.40	296.01	158.40
26	Bath Panel	per m ²	64.84	84.29	97.26	51.87
27	Alcove Front 1400mm x 395mm (Non Standard sizes POA)	Each	48.14	62.59	72.22	38.51
28	Headboard King-Size 1525mm x 600mm	Each	94.72	123.13	142.08	75.78
28	Headboard Double 1370mm x 600mm	Each	87.22	113.39	130.83	69.78
28	Headboard Single 915mm x 600mm	Each	69.20	89.95	103.79	53.36
29	Bedroom Stool - (Supplied unassembled)	Each	52.63	63.17	78.94	42.10
30	Single Mirror (Glazed) - (Supplied unassembled)	Each	71.06	92.39	106.60	56.85
31	Triple Mirror (Glazed) - (Supplied unassembled)	Each	81.35	105.76	122.03	65.08
32	Bottle Rack 2440mm x 80mm	Each	34.05	44.27	51.08	27.24
33	Arched Pelmet Length x 180mm	per lm	18.46	23.99	27.69	14.77
34	Bridging Pelmet Length x 150mm	per lm	18.46	23.99	27.69	14.77
35	Scalloped Pelmet 2440mm x 100mm	Each	34.11	44.34	51.17	27.29
36	Fretwork 2440mm x 120mm	Each	34.05	44.27	51.08	27.24
37	Plate Rack 2440mm x 250mm	Each	34.11	44.34	51.17	27.29
38	Fluted Pilaster Length x 100mm	per lm	18.08	23.51	27.12	14.46
39	Traditional Wine Rack 715mm x 160mm	Each	25.22			20.18
39	Traditional Wine Rack 715mm x 295mm	Each	35.69			28.55
40	Modern Wine Rack 715mm x 160mm	Each	25.22	32.79	37.84	20.18
40	Modern Wine Rack 715mm x 295mm	Each	35.69	46.40	53.53	28.55
41	Shelf Brackets 150mm x 100mm	Pair	18.14	23.59	27.22	14.51
-	Vinyl Foil Length x 1400mm (Min. 1lm)	per lm	15.06	19.58	22.59	
-	Vinyl Foil Peel & Stick Length x 620mm (Min. 1lm)	per lm	13.86	18.02	20.79	
-	Miami / Bilbao integrated door handles in Satin Chrome	Each	3.41	3.41	3.41	
-	Florida / Lisbon integrated door handles in Polished Chrome	Each	3.41	3.41	3.41	

ACCESSORIES CORNICE & PELMET

STOCK OPTIONS

Vinyl Colour	Tangent Cornice	Tangent Light Pelmet	Universal Corpel
African Walnut	✓	✓	✗
Arona Natural Elm	✓	✓	✗
Arona Truffle Elm	✓	✓	✗
Canadian Maple	✓	✓	✓
Carbon Cedar	✗	✗	✓
Classic Walnut	✓	✓	✓
Concrete	✗	✗	✗
Gloss Alabaster	✗	✗	✓
Gloss Aubergine	✗	✗	✓
Gloss Beige	✗	✗	✓
Gloss Black	✗	✗	✓
Gloss Jasmine	✗	✗	✓
Gloss Latte	✗	✗	✓
Gloss Metallic Black	✗	✗	✓
Gloss Metallic Silver	✗	✗	✓
Gloss Red	✗	✗	✓
Gloss Walnut	✗	✗	✓
Gloss White	✗	✗	✓
Gloss Zebrano	✗	✗	✓
Magic Blue	✗	✗	✓
Magic Bronze	✗	✗	✓
Magic Gold	✗	✗	✓
Magic Green	✗	✗	✓
Magic Grey	✗	✗	✓
Modern Graphite	✗	✗	✓
Modern White	✗	✗	✓
Montana Oak	✓	✓	✓
Natural Walnut	✓	✓	✓

Vinyl Colour	Tangent Cornice	Tangent Light Pelmet	Universal Corpel
Odessa Golden Oak Saw Cut	✓	✓	✗
Odessa Grey Oak Saw Cut	✓	✓	✗
Odessa Oak	✓	✓	✗
Pippy Oak	✓	✓	✗
Smooth Basalt	✓	✓	✓
Smooth Dakar	✓	✓	✓
Smooth Ivory	✓	✓	✓
Smooth Kashmir	✓	✓	✓
Smooth Mussel	✓	✓	✓
Smooth Olive	✓	✓	✓
Smooth Porcelain	✓	✓	✓
Smooth Stone	✓	✓	✓
Smooth Vanilla	✓	✓	✓
Smooth White	✓	✓	✓
Sonoma Natural Oak	✓	✓	✗
Sonoma Truffle Oak	✓	✓	✗
Steinberg Beech	✓	✓	✗
Swiss Elm	✓	✓	✗
Traditional Oak	✓	✓	✗
Woodgrain Basalt	✓	✓	✓
Woodgrain Dakar	✓	✓	✓
Woodgrain Ivory	✓	✓	✓
Woodgrain Kashmir	✓	✓	✓
Woodgrain Mussel	✓	✓	✓
Woodgrain Porcelain	✓	✓	✓
Woodgrain Stone	✓	✓	✓
Woodgrain White	✓	✓	✓

PROFILES

1) TANGENT CORNICE

Stock	✓
Length	3m
300x300 Curved	✓
Quadrant	✓
Raw MDF	✓

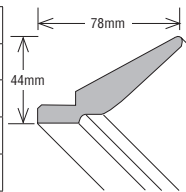

2) TANGENT LIGHT PELMET

Stock	✓
Length: 3m	3m
300x300 Curved	✓
Quadrant	✗
Raw MDF	✓

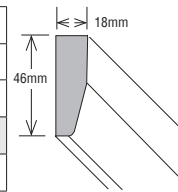

3) UNIVERSAL CORPEL

Stock	✓
Length	3m
300x300 Curved	✗
Quadrant	✗
Raw MDF	✓

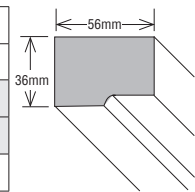

4) 25MM MOULDED CORPEL

Stock	✗
Length	2.4m
300x300 Curved	✓
Quadrant	✓
Raw MDF	✓

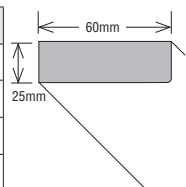

5) RADIUS PROFILE

Stock	✗
Length	3m
300x300 Curved	✗
Quadrant	✗
Raw MDF	✓

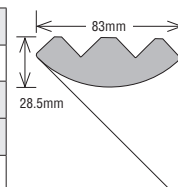

6) 50MM MOULDED CORPEL

Stock	✗
Length	2.4m
300x300 Curved	✓
Quadrant	✓
Raw MDF	✓

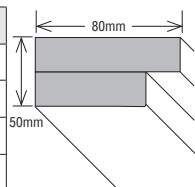

Panels supplied loose

7) CORNER POST

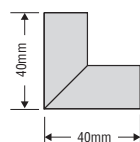

Standard size corner post is supplied at 750mm x 40mm x 40mm.

RADIUS PROFILE ASSEMBLY

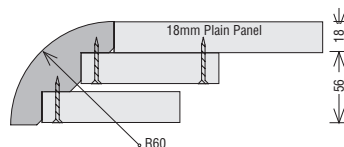

ACCESSORIES

CURVED PROFILES (For illustration purposes only)

8) TANGENT CORNICE
300 x 300 external curve

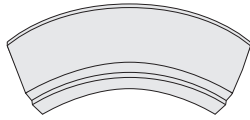

8) TANGENT CORNICE
300 x 300 internal curve

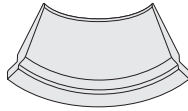

9) TANGENT LIGHT PELMET
300 x 300 external curve

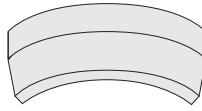

9) TANGENT LIGHT PELMET
300 x 300 internal curve

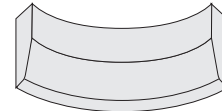

10) TANGENT QUADRANT

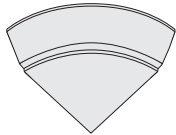

11) 25MM MOULDED CORPEL
300 x 300 external curve

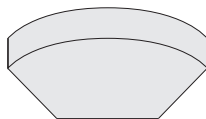

11) 25MM MOULDED CORPEL
300 x 300 internal curve

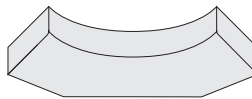

12) 25MM MOULDED CORPEL QUADRANT

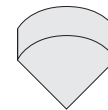

13) 50MM MOULDED CORPEL
300 x 300 external curve

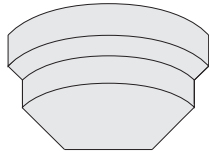

Panels supplied loose

13) 50MM MOULDED CORPEL
300 x 300 internal curve

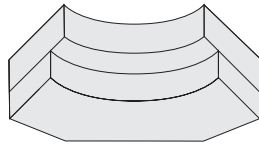

Panels supplied loose

14) 50MM MOULDED CORPEL QUADRANT



Panels supplied loose

15) CURVED PLINTH
Internal & External

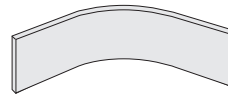

EXTERNAL CURVED CORNER CABINET SPECIFICATION

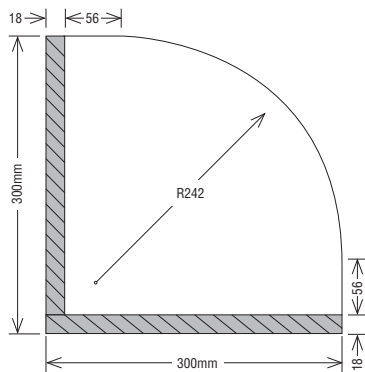

GUIDELINES FOR ORDERING CURVED DOORS

Curved doors and accessories are available with Steel or Ivory backing only.
Curved doors are available in Modern Slab or Siskin Shaker designs only.
Curved doors can be supplied with horizontal grain up to 715mm high and will incur a further 10% charge.

Jigs for cabinets can be supplied on request.

INTERNAL CURVED CORNER CABINET SPECIFICATION

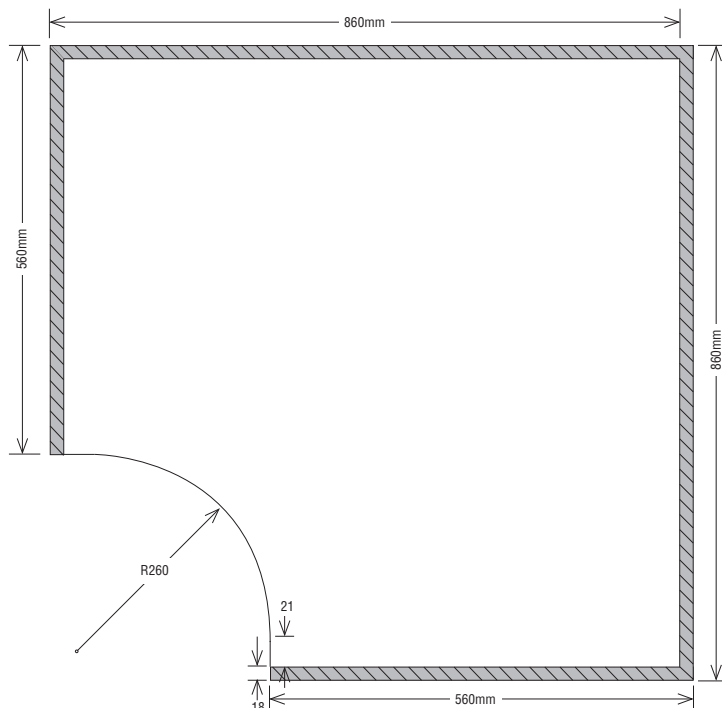

ACCESSORIES PANELS

16) ANGLED PANELS

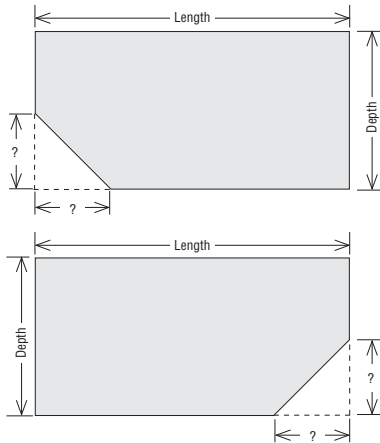

GUIDELINES FOR ANGLED PANELS

A detailed drawing must accompany any order for angled or corner panels giving as much information as possible. Please include all dimensions as shown on the illustrations paying particular attention to the measurements indicated with question marks (?). Always use the terms length and depth when ordering as this will prevent confusion over grain direction which will always be produced to match the direction of the length dimension. State clearly if 18mm (matching back if available) or 25mm (white only) is required and clearly identify any edges which are to be profiled and which profile is required, if not accompanied by a door order.

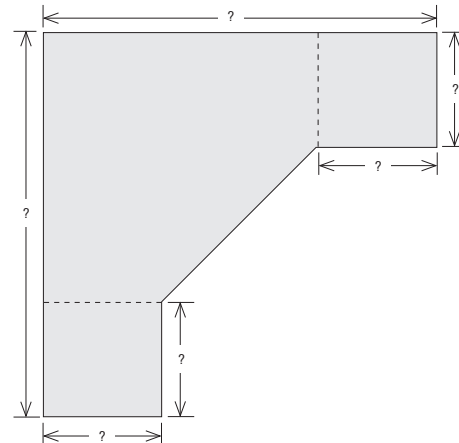

GUIDELINES FOR CORNER PANELS

For unusual shaped panels it is advisable to send us a sketch with as much detail as possible. We will then supply you with a technical drawing which will give full details of how the item will be manufactured.

17) T&G PANELS

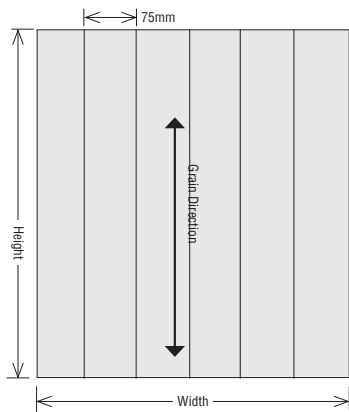

GUIDELINES FOR T&G PANELS

T&G panels can be produced with one long edge moulded A-F and are manufactured with single grooves which are 75mm centre to centre. The height dimension will represent both the direction of the T & G effect and the grain direction where applicable. The usually accepted maximum size available is 2440mm x 800mm. If you require a wider panel or a grain direction which is not accommodated by this size we can manufacture separate components where the joint will coincide with a groove which, while not invisible, will give the effect of a continuous panel. Panels with twin grooves can be manufactured to order, please contact the sales office for further information.

18) MOULDED PANELS

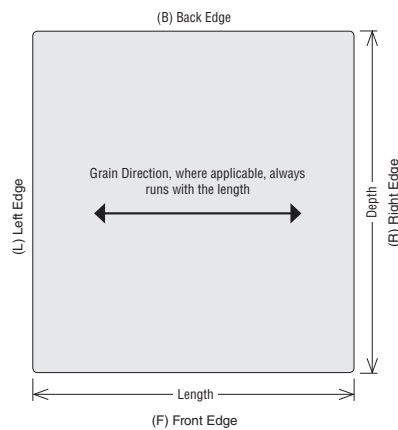

GUIDELINES FOR MOULDED PANELS

The length dimension for any plain or moulded panel will also represent the grain direction where applicable. Please indicate clearly which edges are required with profile by ticking the appropriate box or boxes on the Infinity Collection order form alternatively supply a detailed drawing. 25mm panels are available with white back only.

PANEL PROFILES

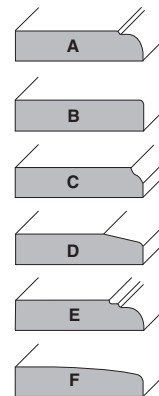

GUIDELINES FOR PANEL PROFILES

These illustrations represent the different edge profiles for the various design options as shown in the Door Finder. Worktops will be supplied with an outside profile to match the door design ordered. If a different profile is required or if purchasing separately from a door order please use the appropriate letter to indicate the edge profile required.

ACCESSORIES CONTINUED

19) WALL SHELF UNITS

Supplied unassembled

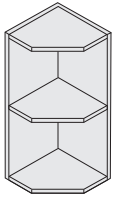

COMPONENT LIST
 3 x Shelves 280mm x 280mm
 1 x Back Panel 720/900mm x 300mm
 1 x Side panel 720/900mm x 282mm

20) CURVED CORNER UNIT

Supplied unassembled

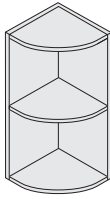

COMPONENT LIST
 3 x Shelves 280mm x 280mm
 1 x Back Panel 720/900mm x 300mm
 1 x Side panel 720/900mm x 282mm

21) BASE SHELF UNITS

Supplied unassembled

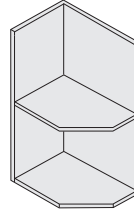

COMPONENT LIST
 2 x shelves 550mm x 280mm
 (specify left or right hand).
 1 x Back Panel 720/900 x 570mm
 1 x Side panel 720/900mm x 282mm

GUIDELINES FOR SHELF UNITS

If ordering non-standard base or wall shelf units be sure to supply full details as right or left handed units will require specific attention with the production of the individual components.

CANOPIES

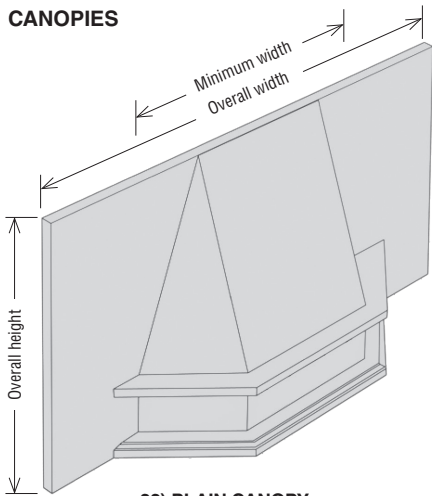

22) PLAIN CANOPY

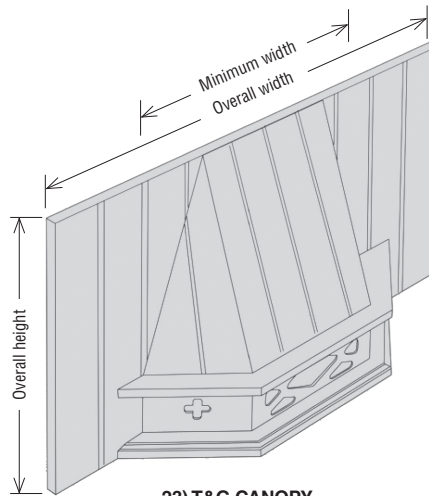

23) T&G CANOPY

GUIDELINES FOR CANOPIES

*Overall width is the complete width of the canopy as supplied from the factory.

**Minimum width is the smallest width that the canopy can be cut down by cutting the backing panel.

The Plain Canopy can be supplied with or without detail on the fretwork.

All canopies are supplied with a matching base board with an overall depth of 400mm

Dimensions	Large Canopy	Small Canopy
Overall Height	450mm	450mm
Overall Width*	1035mm	710mm
Minimum Width**	800mm	600mm

OVERMANTLES

Supplied unassembled

24) OVERMANTLE A

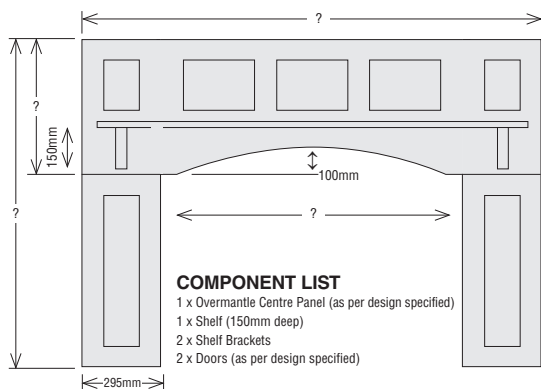

COMPONENT LIST
 1 x Overmantle Centre Panel (as per design specified)
 1 x Shelf (150mm deep)
 2 x Shelf Brackets
 2 x Doors (as per design specified)

25) OVERMANTLE B

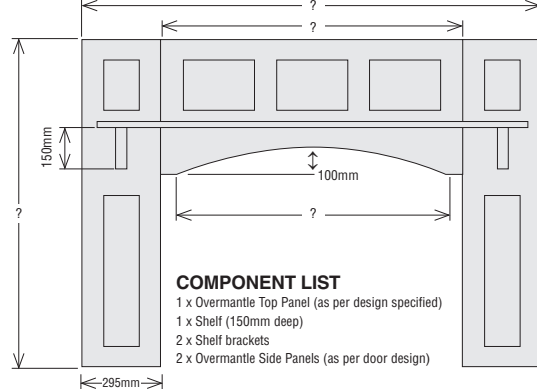

COMPONENT LIST
 1 x Overmantle Top Panel (as per design specified)
 1 x Shelf (150mm deep)
 2 x Shelf brackets
 2 x Overmantle Side Panels (as per door design)

GUIDELINES FOR PANEL PROFILES

Drawings A and B represent the two methods of manufacturing over mantles with the fixed dimensions shown. The measurements indicated by question marks (?) can be altered to suit your order requirements as can the design. When ordering, please provide full details of door design, dimensions of all components and clearly indicate any profiled edges. A technical drawing and quotation will be sent for customer approval before manufacture. Price based on 1300mm high x 1600mm wide. Larger sizes available. Price on application.

ACCESSORIES CONTINUED

26) BATH PANEL

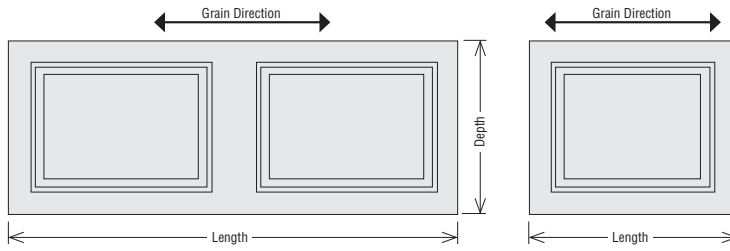

GUIDELINES FOR ORDERING BATH PANELS

Bath panels can be manufactured to match any of our available door designs but will be produced with square edges all round. Please supply all dimensions when ordering and always use the terms length and depth as this will prevent confusion over grain direction. Pay particular attention to the length dimension which will determine the grain direction where applicable.

27) ALCOVE

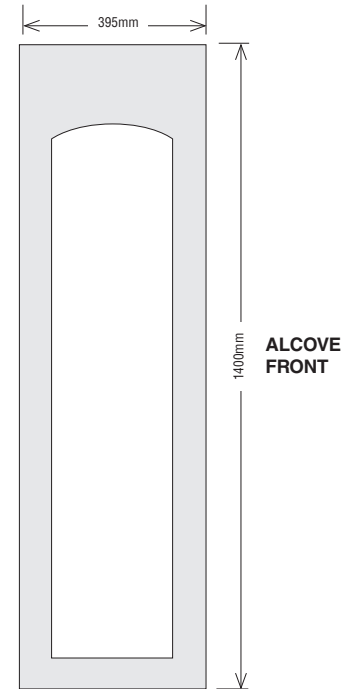

GUIDELINES FOR ALCOVES

The standard size for an Alcove front is 1400mm x 395mm. Non-Standard sizes can also be supplied and will be priced on application.

28) HEADBOARDS



GUIDELINES FOR ORDERING HEADBOARDS

For unusual shaped panels it is advisable to send us a sketch with as much detail as possible. We will then supply you with a technical drawing which will give full details of how the item will be manufactured.

29) BEDROOM STOOL

Supplied unassembled

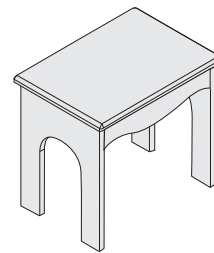

MIRRORS

Supplied unassembled

30) SINGLE MIRROR

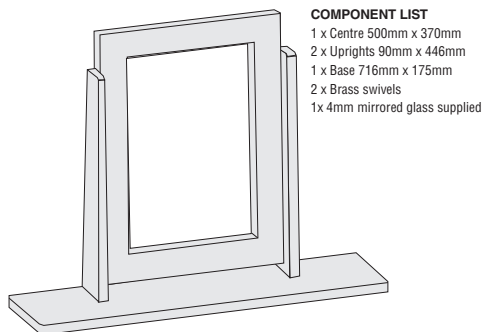

COMPONENT LIST
 1 x Centre 500mm x 370mm
 2 x Uprights 90mm x 446mm
 1 x Base 716mm x 175mm
 2 x Brass swivels
 1 x 4mm mirrored glass supplied

31) TRIPLE MIRROR

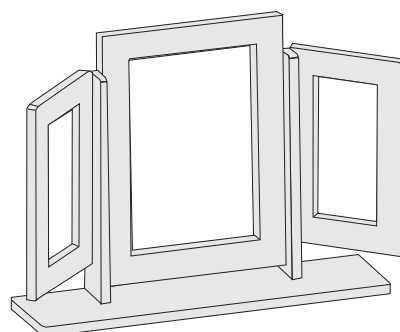

COMPONENT LIST
 1 x Centre 500mm x 370mm
 2 x Uprights 90mm x 446mm
 1 x Base 716mm x 175mm
 2 x Wings x 2 370 x 400mm
 2 x Brass swivels
 4 x Brass hinges
 3 x 4mm mirrored glass supplied

GUIDELINES FOR MIRRORS

Mirrors are supplied glazed and flat packed complete with all necessary fittings and assembly instructions.

ACCESSORIES CONTINUED

FASCIAS

32) BOTTLE RACK

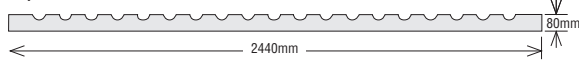

33) ARCHED PELMET

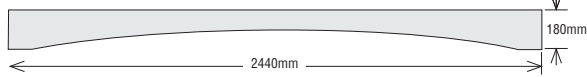

34) BRIDGING PELMET

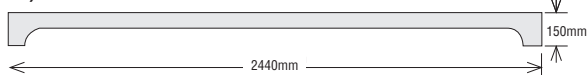

35) SCALLOPED PELMET

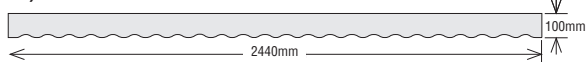

36) FRETWORK

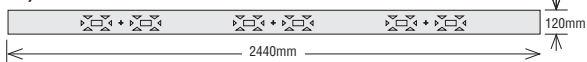

37) PLATE RACK

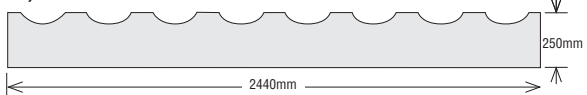

38) FLUTED PILASTER

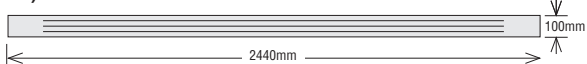

GUIDELINES FOR FASCIAS

Arched pelmet, Bridging pelmet and Fluted pilaster minimum length available is 500mm, max length is 2440mm. These drawings are for illustration purposes only.

DRILLING

INFINITY & DENOVO

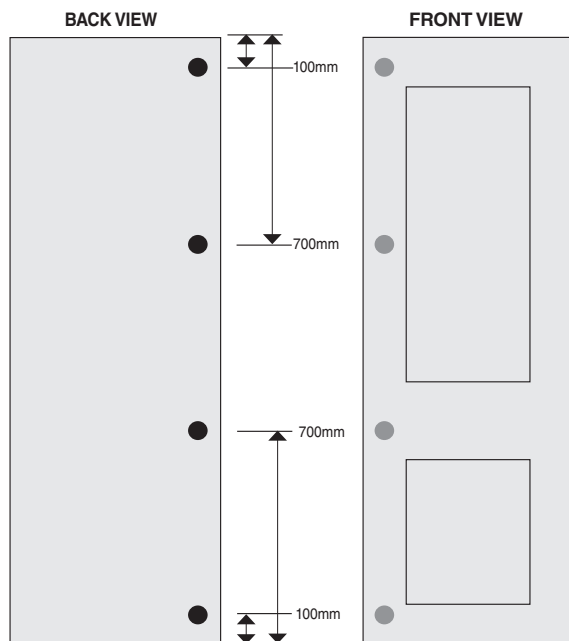

Eg. 100/700 T - 100/700 B

WINE RACK FASCIAS

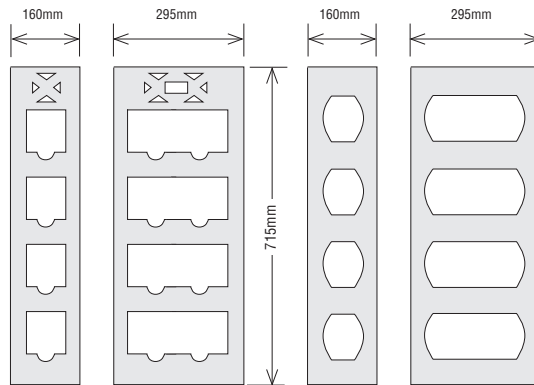

39) TRADITIONAL WINE RACK

40) MODERN WINE RACK

GUIDELINES FOR WINE RACKS

Gloss wine racks are available in modern design only. Non-standard sizes are available and will be priced on application.

41) SHELF BRACKETS

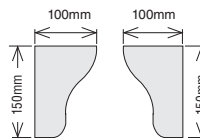

Shelf brackets are supplied as a pair.

GUIDELINES FOR DRILLING

This example shows a door drilled with four left hand hinge holes. The following abbreviations are used on order acknowledgements to indicate drilling specifications.

- T - drilled from top down
- B - drilled from bottom up
- C - drilled in the centre
- LHH - Left hand hinges
- RHH - Right hand hinges
- THH - top hung hinges

Hinge holes are supplied at £0.75 per hole. Normal discounts do not apply.

When ordering hinging on Bilbao/Miami, Eclipse and Florida/Lisbon designs please advise if for base or wall units as this will affect handing.

Hinge holes are drilled 35mm diameter and 5mm from the edge of the door and are 12.5mm deep.

Door Size	Hinge Holes	Processing Format
Up to 894	2	100 T - 100 B
895 - 1499	3	100 T - C - 100 B
1500 and above	4	100/300 T - 100/300 B

Examples of drilling specification

ACRYLIC SOLID COLOURS PRICE MATRIX

		Width up to (mm)										
		296	396	446	496	596	646	696	796	896	996	
Drawer Fronts	115	9.28	11.92	13.24	14.55	17.19	18.50	19.82	22.46	25.10	27.73	
	140	9.94	12.72	14.10	15.49	18.27	19.66	21.04	23.81	26.60	29.37	
	175	11.50	14.66	16.23	17.82	20.98	22.55	24.13	27.29	30.45	33.60	
	215	12.59	15.99	17.69	19.39	22.81	24.51	26.21	29.61	33.01	36.41	
Pan Drawers	283	14.61	18.48	20.42	22.37	26.24	28.18	30.12	34.00	37.87	41.76	
	355	17.48	22.06	24.35	26.65	31.23	33.52	35.81	40.38	44.97	49.55	
Doors	Height up to (mm)	415	19.88	25.04	27.63	30.21	35.37	37.97	40.54	45.71	50.87	56.04
		450	21.28	26.79	29.54	32.30	37.80	40.55	43.30	48.81	54.32	59.83
		500	21.90	27.55	30.37	33.19	38.83	41.65	44.48	50.12	55.76	61.40
		535	22.35	28.09	30.96	33.83	39.57	42.44	45.31	51.05	56.79	62.53
		570	23.01	28.90	31.85	34.79	40.68	43.63	46.58	52.47	58.36	64.25
		715	23.61	29.62	32.61	35.62	41.61	44.61	47.61	53.60	59.60	65.60
		900	32.33	40.48	44.55	48.63	56.78	60.86	64.93	73.08	81.23	89.38
		1060	38.14	47.70	52.49	57.27	66.84	71.62	76.41	85.97	95.55	105.12
		1245	44.93	56.16	61.78	67.40	78.62	84.24	89.86	101.09	112.33	123.55
Tall Doors	Height up to (mm)	1735	61.51	76.80	84.43	92.07	107.35	115.00	122.64	137.92	153.20	168.47
		2150	75.73	94.48	103.86	113.23	131.97	141.35	150.73	169.48	188.23	206.98
		2250	78.94	98.48	108.24	118.01	137.55	147.32	157.08	176.62	196.15	215.69
		2400	84.02	104.79	115.19	125.57	146.34	159.23	169.80	187.89	208.67	229.44

Maximum Door & Panel Size is 2400mm x 1200mm, Minimum Door & Panel Size is 100mm x 100mm

ACRYLIC METALLIC COLOURS PRICE MATRIX

		Width up to (mm)										
		296	396	446	496	596	646	696	796	896	996	
Drawer Fronts	115	10.22	13.11	14.56	16.01	18.91	20.36	21.81	24.71	27.60	30.50	
	140	10.93	13.99	15.51	17.04	20.10	21.62	23.14	26.20	29.25	32.31	
	175	12.65	16.13	17.86	19.60	23.07	24.81	26.54	30.02	33.50	36.96	
	215	13.85	17.59	19.47	21.34	25.08	26.96	28.82	32.57	36.32	40.06	
Pan Drawers	283	16.07	20.33	22.47	24.60	28.86	31.00	33.13	37.40	41.66	45.93	
	355	19.24	24.27	26.79	29.31	34.35	36.87	39.39	44.43	49.47	54.51	
Doors	Height up to (mm)	415	21.87	27.55	30.39	33.23	38.91	41.76	44.59	50.28	55.97	61.65
		450	23.40	29.46	32.50	35.52	41.58	44.60	47.64	53.70	59.76	65.81
		500	24.10	30.30	33.41	36.51	42.71	45.82	48.92	55.13	61.34	67.55
		535	24.59	30.90	34.06	37.21	43.53	46.68	49.84	56.15	62.48	68.79
		570	25.31	31.78	35.03	38.27	44.75	48.00	51.23	57.71	64.20	70.68
		715	25.98	32.58	35.88	39.18	45.77	49.08	52.37	58.97	65.56	72.16
		900	35.56	44.53	49.01	53.50	62.45	66.94	71.42	80.39	89.36	98.31
		1060	41.95	52.47	57.74	63.00	73.52	78.78	84.05	94.57	105.11	115.63
		1245	49.42	61.78	67.96	74.13	86.49	92.66	98.85	111.21	123.55	135.91
Tall Doors	Height up to (mm)	1735	67.66	84.47	92.87	101.28	118.09	126.49	134.90	151.70	168.51	185.33
		2150	83.30	103.93	114.24	124.55	145.17	155.49	165.81	186.43	207.05	227.68
		2250	86.84	108.33	119.07	129.81	151.31	162.05	172.79	194.28	215.76	237.26
		2400	92.42	115.27	126.70	138.13	160.98	175.16	186.77	206.68	229.53	252.38

Maximum Door & Panel Size is 2400mm x 1200mm, Minimum Door & Panel Size is 100mm x 100mm



DUO
Glass effect edging



MATCHING
High gloss matching edging



ACCESSORIES

Accessory	Solid Colours	Metallic Colours
19mm Panel (edged all sides with matching gloss edging only)	as door price	as door price
38mm Block Panels (edged all sides with matching gloss edging only)	as door price +60%	as door price +60%
Plinth 2400mm x 150mm (un-edged)	32.61	35.88
38mm Block Cornice 2400mm x 75mm x 38mm	36.73	40.40
38mm Block Gable	as door price +30%	as door price +30%
Vuplex 50g Bottle	£6.50	
Vuplex 200g Bottle	£12.00	
Vuplex 375g Bottle	£17.63	
Micro-fibre Cloth	£1.43	

BLOCK GABLE

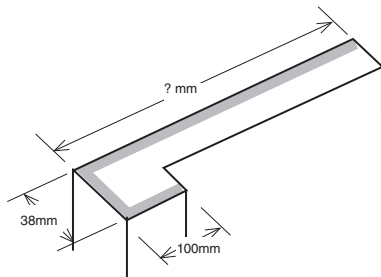

TOPX ACRYLIC SURFACES

All of our acrylic colours (with the exception of Metallic Blue) are supplied with the new harder wearing TopX surface finish.

The surface of TopX is covered with a protective film up to the time of use, which means up to the point of everyday use in the kitchen or bathroom. The protective film must stay on the surface during processing and installation. After removal of the film, the surface is ready for daily use. No additional polishing is necessary.

For general cleaning TopX, normally available cleaning agents can be used. For special care of the surface, we recommend using VuPlex®.

Important: the use of abrasive effect cleaning agents and scouring agents can cause damage and should be avoided. The surface of TopX is, however, resistant to many chemicals. In case of doubt, suitability and resistance should be checked on a sample surface.

Benefits of the new TopX surface finish

- Greatly improved scratch resistance, steel wool proven
- No polishing necessary after removal of the protective film
- Increased UV stability
- High chemical resistance

VUPLEX KIT



PRODUCT CARE, GUARANTEE & REPLACEMENT POLICY

Doors and accessories from the Infinity and deNovo ranges in the NEY Door Collection carry a guarantee of 5 years from date of invoice, against defects in materials only.

Doors should be cleaned using a damp cloth using a very mild solution of water and household detergent (non-abrasive) with a minimum amount of moisture. No water should be left on the surface for any length of time and should be dried using a soft, clean cloth.

NEY will not accept any liability for damage caused by excessive use of detergents or cleaning materials containing solvents.

To prevent heat damage we advise the following precautions :-

- i. Extractors are always used above working hobs.
- ii. Heat deflectors should be fitted around Built-in/under ovens and ranges to minimise heat emissions.
- iii. Not positioning kettles, toasters etc. in locations where the heat or steam they emit will over a period of time damage wrapped products.

If storing product for any period of time we recommend you do so flat in a dry environment. NEY cannot be held responsible if product is stored or installed in a newly plastered or damp environment.

Where a product is damaged or sub-standard when receiving delivery, it is the Buyers responsibility to sign the delivery documents

as damaged. If damaged goods are received, in order to speed the replacement process, the Sales Office require photographic evidence of the damage along with a list of items and a copy of the delivery document which states the damage. Chargeable replacements will be ordered and manufactured and a request will be sent to the Area Sales Representative to arrange collection and credit of the faulty product. Any faulty doors should not be used, i.e. drilled or fitted, without prior agreement with Ney Ltd.

If product has already been installed it is reasonable to assume that they met with the Buyers quality standards before installation. We cannot be held responsible for faults if not informed prior to installation.

If product has been installed and a fault found, NEY will issue a chargeable replacement, the Area Sales Representative will then endeavour to collect the goods for inspection and credit. NEY request that the Buyer, where possible, forward photographic evidence of the fault and details of the original invoice for NEY to process the claim.

Please note that in the event of a proven manufacturing defect, NEY's liability will not exceed the value of the defective product and accept no liability for any consequential loss, loss of profits, third party claims or refitting charges.

HANDLING AND STORAGE INSTRUCTIONS:



Our doors are heavy and can be damaged if they are not handled carefully. Do not drag doors or slide them across one another, as this can result in chipping damage or scratching. Handling damage is not considered a factory defect.



Doors must be stored in a dry, well ventilated area in an enclosed building. Do not deliver doors to the job site until concrete floors, foundations and plastering is completed and fully dry. Never store doors outside, exposed to the elements.



Do not subject doors to extremes of heat, dryness or humidity. Temperature should not exceed 40° C.



Doors should be stored flat on a level surface in a dry, ventilated area to prevent bowing. It is very important to support the centre of the doors to prevent them from sagging in the middle. Do not lean doors against the wall.

Do

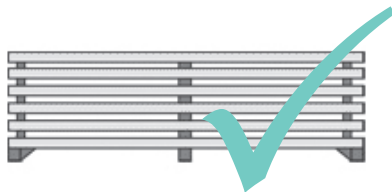

Don't

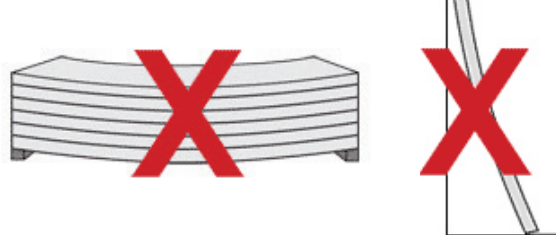

We are constantly improving our product range and whilst we will endeavour to keep you informed, we also reserve the right to amend colours, specification or products without prior notification.













HANDLE COLLECTION DESIGNS

CONTEMPORARY DESIGNS



TRADITIONAL DESIGNS



- | | | |
|--|---|---|
|  AB Antique Brass |  NB Nickel Black |  SS Satin Stainless Steel |
|  AS Antique Steel |  PB Polished Brass |  CPMSC Polished Chrome/Matt Satin Chrome |
|  BA Black Antique |  PE Pewter Effect |  SNCP Satin Nickel/Polished Chrome |
|  CP Polished Chrome |  SC Satin Chrome |  SNSS Satin Nickel/Stainless Steel |
|  MSC Matt Satin Chrome |  SN Satin Nickel (Brushed Nickel) | |

HANDLE COLLECTION PRICE LIST

PART NO	COLOUR	WIDTH	HOLE CENTRE	HEIGHT	COST	PART NO	COLOUR	WIDTH	HOLE CENTRE	HEIGHT	COST
H6850 160	SN	180	160	41	4.78	H4225 224	CPMSC	236	224	36	5.15
H6850 192	SN	212	192	41	5.52	H4225 320	CPMSC	332	320	36	6.58
H6850 224	SN	244	224	41	5.52	H4225 448	CPMSC	460	448	36	8.50
H4700 128	SNCP	140	128	32	1.95	H4225 160	SNCP	172	160	36	4.86
H4700 160	SNCP	172	160	32	2.23	H4225 224	SNCP	236	224	36	6.08
H4700 192	SNCP	204	192	32	2.45	H4225 320	SNCP	332	320	36	7.73
H4700 224	SNCP	236	224	32	2.68	H4225 448	SNCP	460	448	36	10.48
H4700 448	SNCP	460	448	32	4.05	H4500 096	CP, MSC, SN	119	96	30	0.78
H4700 576	SNCP	588	576	32	4.93	H4500 128	CP, MSC, SN	153	128	31	0.98
H4800 160	SNSS	184	160	43	6.45	H4500 160	CP, MSC, SN	190	160	32	1.03
H4800 256	SNSS	280	256	43	7.40	H4500 192	CP, MSC, SN	226	192	32	1.08
H4800 352	SNSS	376	352	43	8.70	H4500 224	CP, MSC, SN	256	224	32	1.53
H4800 448	SNSS	472	448	43	9.00	H4500 288	CP, MSC, SN	338	288	33	1.78
H4800 608	SNSS	632	608	43	11.83	H4500 320	CP, MSC, SN	372	320	36	1.93
H4450 096	CP, SC, SN	156	96	35	1.33	H4500 352	CP, MSC, SN	408	352	38	2.20
H4450 128	CP, SC, SN	188	128	35	0.98	H2300 096	CP, SN	122	96	27	1.23
H4450 160	CP, SC, SN	220	160	35	1.60	H2300 128	CP, SN	156	128	27	1.50
H4450 192	CP, SC, SN	252	192	35	1.13	H2000 096	SC	116	96	30	1.20
H4450 224	CP, SC, SN	284	224	35	2.10	H2000 128	SC	150	128	31	1.75
H4450 288	CP, SC, SN	348	288	35	1.60	H2720 096	CP, SN	120	96	26	1.82
H4450 352	CP, SC, SN	412	352	35	2.68	H2720 128	CP, SN	162	128	29	2.39
H4450 384	CP, SC, SN	444	384	35	2.63	H2750 096	NB, SN	142	96	24	1.20
H4450 448	CP, SC, SN	508	448	35	3.15	H2750 128	NB, SN	184	128	27	1.53
H4450 512	CP, SC, SN	572	512	35	3.43	H2060 128	SN	205	128	28	1.88
H4450 608	CP, SC, SN	668	608	35	4.20	H2060 160	SN	235	160	32	2.83
H4450 640	CP, SC, SN	700	640	35	4.23	H3300 160	CP, NB, SN	175	160	30	2.68
H4450 768	CP, SC, SN	828	768	35	4.65	H3160 160	CP, SN	170	160	24	2.40
H4450 864	CP, SC, SN	924	864	35	5.25	H3160 224	CP, SN	238	224	34	4.00
H4450 960	CP, SC, SN	1020	960	35	5.88	H3440 128	SN	154	128	26	1.43
H4450 1024	CP, SC, SN	1084	1024	35	7.65	H2550 128	SS	136	128	30	5.68
H2065 160	CP, SN	202	160	32	3.60	H2550 160	SS	168	160	30	6.30
H2035 128	CP, SN	144	128	24	1.65	H2550 192	SS	200	192	30	6.55
H2035 160	CP, SN	173	160	26	1.98	H2550 224	SS	232	224	30	6.98
H3550 128	NB, SN	143	128	37	4.55	H2500 128	SS	197	128	30	4.95
H3550 160	NB, SN	175	160	37	4.55	H2500 160	SS	229	160	30	5.23
H3550 192	NB, SN	207	192	37	5.30	H2500 192	SS	260	192	30	5.63
H3550 224	NB, SN	239	224	37	5.13	H2500 224	SS	292	224	30	6.13
H3550 320	NB, SN	335	320	37	5.38	H3065 128	CP, SN	163	128	25	2.23
H3550 448	NB, SN	463	448	37	9.20	H3065 160	CP, SN	193	160	26	2.83
H2010 128	CP, MSC, SN	142	128	28	0.95	H3065 192	CP, SN	225	192	26	3.38
H2010 224	CP, MSC, SN	288	224	33	2.60	H3065 256	CP, SN	289	256	26	4.35
H4210 128	CPMSC	161	128	27	2.65	H2090 160	CP, SN	192	160	26	4.15
H4210 160	CP, MSC, SN	193	160	27	2.83	H2090 224	CP, SN	256	224	26	5.08
H4210 224	CP, MSC, SN	257	224	27	3.15	H2045 096	MSC, SN	172	96	18	1.00
H4210 320	CP, MSC, SN	354	320	27	3.60	H2045 128	MSC, SN	201	128	18	1.13
H4210 448	CP, MSC, SN	481	448	27	4.25	H5560 064	CP, SN	87	64	25	1.83
H4210 128	SNCP	161	128	27	2.75	H2350 028	CP, SN	28 dia	12 dia	24	0.75
H4210 160	SNCP	193	160	27	3.03	H2350 33	CP, SN	33 dia	14 dia	27	1.20
H4210 224	SNCP	257	224	27	3.53	HK4900 028	CP, PB, SN, MSC	28 dia	30 dia	29	4.53
H4210 320	SNCP	354	320	27	4.28	HK4900 35	CP, PB, SN, MSC	35 dia	38 dia	36	7.13
H4210 448	SNCP	481	448	27	5.28	H4025 048	CP	48/48	32	23	2.05
H4215 160	CPMSC	200	160	27	3.43	H4025 048	SN	48/48	32	23	2.05
H4215 224	CPMSC	264	224	27	4.55	HK5750 124	AB, AS, BA	124	20 dia	53	3.23
H4215 320	CPMSC	360	320	27	4.55	H5575 128	PE	169	128	26	7.85
H4215 448	CPMSC	488	448	27	5.23	H6050 128	NB, SN	151	128	39	8.73
H4215 160	SNCP	200	160	27	4.00	H1250 128	AS	142	128	26	2.75
H4215 224	SNCP	264	224	27	4.55	H1250 160	AS	181	160	26	2.98
H4215 320	SNCP	360	320	27	5.6	H5540 032	PE	32/32	12 dia	23	3.08
H4215 448	SNCP	488	448	27	6.63	H5565 128	PE	158	128	38	5.20
H4225 160	CPMSC	172	160	36	4.86	H5565 160	PE	190	160	40	5.75

